

BeFREE 10

10.4" Touchcomputer with InterCom



TECHNICAL OVERVIEW

Description and Application

BeFREE10_TO_1_5.doc
Version 1.5 (hardware version 4.0)
May 23, 2019



TABLE OF CONTENTS

A. GENERAL INFORMATION	A-1
A.1. Highlights	A-1
A.2. Technical Characteristics	A-2
B. INTEGRAL PARTS AND FUNCTIONALITY	B-1
B.1. Operator Interface.....	B-1
B.2. Touchmonitor	B-3
B.3. Embedded Computer.....	B-3
B.4. Intercom (Audio Section).....	B-4
B.4.1. Microphone Amplifier	B-5
B.4.2. Hands-Free Amplifier	B-5
B.4.3. Alarm/Alert Amplifier	B-5
B.4.4. Central Speaker Amplifier	B-5
B.4.5. Bar-Graph Display	B-6
B.4.6. Incremental Encoder	B-6
B.5. External Connectors	B-7
B.5.1. External Digital Inputs.....	B-7
C. OPERATION	C-1
C.1. Configuring BeFREE 10	C-1
C.2. Applying BeFREE 10.....	C-1
D. OPTIONS.....	D-1
D.1. Inclination Mechanism.....	D-1
D.2. HID Telephony Interface	D-1
D.3. Echo-Cancellation Circuitry.....	D-2
D.4. Goose-Neck Microphone	D-2
E. ORDERING CODES	E-1
E.1. BeFREE 10	E-1
E.2. Inclination Mechanism	E-2
F. REFERENCES	F-1
G. NOTICES.....	G-1
G.1. Disclaimer	G-1
G.2. Copyright Notice	G-1

A. GENERAL INFORMATION

The **BeFREE 10** (BF 10) is a member of the modular **FREE** (also referred to as FREE/FREE+/BeFREE) product family, integrating a 10.4" touchmonitor, a computer and an intercom device. It is compatible and combinable with all existing **FREE** modules. The touchmonitor comprises a high resolution (XGA), ultra-wide viewing angle TFT LCD and 5-wire resistive touchscreen. The computer is based on a main-board with Intel quad-core Celeron processor (**J1900**) and a solid state disk. Thanks to low-power components and the corresponding electronic and thermal design the BeFREE 10 is completely silent and without moving parts.

The Intercom section consists of a goose-neck microphone, illuminated PTT key, stereo loudspeakers, volume control knob and VU-meter. Its primary audio interface is USB, but it is also connected to the analogue sound card of the embedded computer. This dual interface results in up to four listening (output) channels and two parallel recording (input) channels. Status of the PTT key is reported via HID Keyboard and/or HID Telephony interface.

A.1. Highlights

FEATURES

- ◆ space-saving integration of a fanless touchcomputer and an intercom
- ◆ modular – combinable with other **FREE** modules into multifunctional terminals
- ◆ low-profile horizontal design
- ◆ silent and reliable - no moving parts, industrial grade components, Ethernet redundancy, redundant internal audio and controller interfaces
- ◆ extensive connectivity (LAN, USB, COM, external display, digital inputs)
- ◆ cable management – hidden and secured, but accessible
- ◆ built-in Tipro controller enables:
 - modularity and programmability
 - energy saving modes
 - touchscreen disable/enable control
 - brightness adjustment
 - five programmable keys
 - two programmable digital inputs (e.g. for an external PTT switch/pedal)
- ◆ stereo loudspeakers (2 x 2W) with volume control encoder
- ◆ additional low-frequency loudspeaker (1 x 3W) with programmable equalizer
- ◆ total 7 W output power

- ◆ goose-neck microphone with illuminated PTT key
- ◆ three-colour bar-graph display
- ◆ three mechanical keys for brightness control and other functions
- ◆ mechanical key-switch inside the encoder for bar-graph control
- ◆ several LED indicators (power, SSD, microphone, speakers, touchscreen ...)
- ◆ optional Inclination Mechanism (VESA 75)

APPLICATIONS

- ◆ operator/dispatcher terminals/consols for command and control centres in:
 - transport and traffic control (railways, air traffic ...)
 - public safety (police, fire brigades, ambulance ...)
 - utilities (electricity, gas ...)
 - building/facility management systems (airports, banks, industrial plants ...)
- ◆ trading and banking consoles
- ◆ multifunctional control panels

A.2. Technical Characteristics

ELECTRICAL

- ◆ **power supply:** 12V ± 5% (from an external AC/DC adapter)
- ◆ **power consumption:**

Operating Mode	Typical	Maximal
OFF (power saving)	0.2 W	TBD
SLEEP (Windows standby)	3.0 W	TBD
IDLE	16.5 W	TBD
ACTIVE	21.0 W	32.0 W

Note 1: Values in the table above are temporary approximations of typical consumption, obtained by measurements at the 12V power input of the BeFREE 10 (LCD at full brightness) without any additional Tipro modules and without any other peripherals connected. Terminology for Operating Modes is taken from “ENERGY STAR Program Requirements for Computers: Version 5.0”.

- ◆ **internal interface and power connectors** (to provide for modularity):
 - **left-hand side Tipro Bus connector:** 6-pin Micro-MaTch header (male) at the end of a 6-wire ribbon cable
 - **right-hand side Tipro Bus connector:** 6-pin Micro-MaTch header (male) at the end of a 6-wire ribbon cable

- ◆ **external interface and power connectors** (to provide for external expansions):
 - **standard computer interfaces:** LAN, USB, COM, VGA ... (see Chapter B.5 for details)

MECHANICAL

- ◆ **caseing:** plastic ABS, black (C15) colour with matte black (C25) top part
- ◆ **gross dimensions** (with side-covers): 332 x 278 x 100 (W x D x H) [mm]
- ◆ **goose-neck microphone length/height:** 350±50mm
- ◆ **weight:** 3.9 kg (approximately)
- ◆ **protection (sealing) grade:** IP 20 (according to EN 60529)

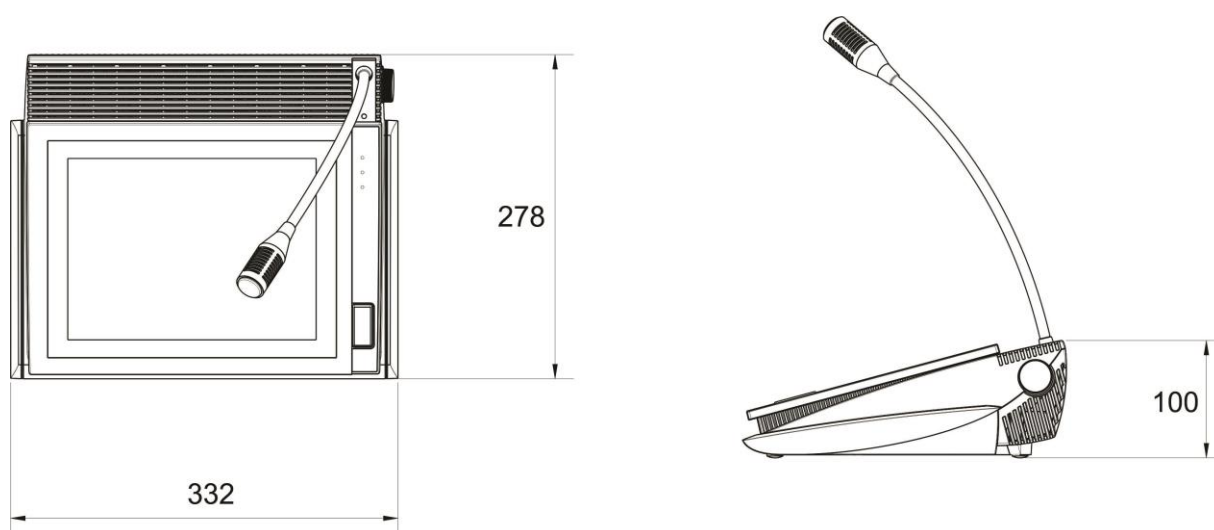

Figure A.1 Physical Dimensions

ENVIRONMENTAL

- ◆ **operating ambient temperature range:** +5°C to +35°C
- ◆ **storage ambient temperature range:** -10°C to 50°C
- ◆ **relative humidity range:** 20% to 80% (non-condensing)

EMBEDDED COMPUTER

- ◆ **Processor (SoC)**
 - Intel Celeron J1900 2.0 GHz (2.42 GHz burst frequency)
- ◆ **Chipset**
 - Northbridge functionality integrated in the SoC
 - Southbridge functionality integrated in the SoC
- ◆ **System Memory**
 - 4GB DDR3L - 1333

- ◆ **Video**
 - graphic processor integrated in the SoC
 - dual independent display support
 - resolution: up to 2560x1600
- ◆ **Dual Ethernet:**
 - 2 x Intel I211, 10/100/1000 Base-TX
- ◆ **Audio**
 - Analogue Line In and Line Out (internally connected to Intercom)
- ◆ **Mass Storage**
 - **type:** Solid State Disk
 - **technology:** Multi-Level Cell (MLC) NAND
 - **interface:** SATA II - 3 Gb/s
 - **form factor:** 2.5"
 - **capacity:** ≥ 120 GB

DISPLAY

- ◆ **type:** TFT LCD
- ◆ **size:** 10.4" diagonal
- ◆ **aspect ratio:** 4:3
- ◆ **native resolution:** 1024 × 768 (XGA)
- ◆ **luminance/brightness (typical):** ≥ 350 cd/m²
- ◆ **contrast ratio (typical):** $\geq 500:1$
- ◆ **backlight lifetime (typical):** $\geq 35,000$ hours

TOUCHSCREEN

- ◆ **technology:** 5-wire resistive (ELO)
- ◆ **positional accuracy:** 2.03 mm (standard deviation of error)
- ◆ **positional accuracy:** ± 4.572 mm (maximum error)
- ◆ **touch activation force:** < 113 g (typically)
- ◆ **controller resolution:** 4096 x 4096 touch points
- ◆ **light transmission:** 80 ± 5 % (at 550 nm wavelength)
- ◆ **lifetime:** 35×10^6 touches in one location

AUDIO SECTION (INTERCOM)

- ◆ **Loudspeakers (Left / Voice and Right / Alert)**
 - two in parallel within the left output
 - two in parallel within the right output
 - type: dynamic
 - rated power: 3 W

- output sound pressure level (SPL): 78 dB ± 3 dB @ 1 W @ 1 kHz @ 1.0 m distance
- ◆ **Loudspeaker (Central)**
 - type: dynamic
 - rated power: 4W
 - output sound pressure level (SPL): 79 dB ± 3 dB @ 1 W @ 1 kHz @ 1.0 m distance
- ◆ **Goose-neck Microphone**
 - type: electret condenser, unidirectional
 - max input: 120 dB SPL
- ◆ **Analogue Amplifiers**
 - designed to meet wide-band IP telephony standards
 - frequency pass-band: (100 Hz - 8 kHz) TYP
 - output power: 7 W (2 x 2 x 1 W + 1 x 3 W)
- ◆ **USB Audio Codec**
 - model: Texas Instruments PCM 2902C
 - USB Interface: full-speed, USB 2.0 compliant, certified by USB-IF
 - resolution: 16-bit Delta-Sigma ADC and DAC
 - sampling rates (ADC): 8, 11.025, 16, 22.05, 32, 44.1, 48 kHz
 - sampling rates (DAC): 32, 44.1, 48 kHz
 - recommended data format: **16-bit** (rather than 8-bit), **stereo** (rather than mono)

MECHANICAL KEYS

- ◆ **Push To Talk Key** (two key-switches in parallel)
 - model: Cherry MX
 - key travel: 3.6mm to 4.0mm total, (2 ± 0.6) mm pretravel
 - actuating force: (60 ± 20) cN
 - reliability (Mean Cycles To Failure): MCTF = 1 billion (10⁹) press/release cycles (50 million is guaranteed minimum)
- ◆ **Control Keys**
 - model: Diptronic DTS
 - key travel (typical): 0.3mm
 - actuating force (typical): 255 cN
 - lifetime (minimal): 0.5 million operations

B. INTEGRAL PARTS AND FUNCTIONALITY

BeFREE 10 represents an integration of a touchmonitor (display with touchscreen), a computer, an intercom and a controller.



Figure B.1 Operator Interface of BeFREE 10

B.1. Operator Interface

The **Stripe** (see Figure B.2 below) is an ergonomically designed vertical area along the right-hand side of the display. It comprises a number of visual indicators and mechanical keys (short-travel) to provide the operator with a quick insight and immediate access to important controls. The most prominent position is assigned to the PTT key, which consists of two long-travel mechanical key-switches and a large actuator with dimmable background illumination.











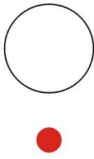

	<table border="1"> <tr> <td>Microphone LED</td> <td>Illuminated (red) while the microphone is active.</td> </tr> </table>	Microphone LED	Illuminated (red) while the microphone is active.								
Microphone LED	Illuminated (red) while the microphone is active.										
<p>TIPRO</p>          	<table border="1"> <tr> <td>Speaker Indicator</td> <td>Indicates speaker being adjusted</td> </tr> <tr> <td>Brightness UP Key</td> <td>Press to increase brightness of the display and all visual indicators.</td> </tr> <tr> <td>Brightness DOWN Key</td> <td>Press to decrease brightness of the display and all visual indicators.</td> </tr> <tr> <td>Home / TouchDisable Key</td> <td>Long press disables touchscreen. The LED indicator (lock) is illuminated (red) while touch is disabled. Short press (re)enables touchscreen.</td> </tr> <tr> <td>Status Indicators</td> <td>Power, Disk Activity and Warning. See Figure B.3 for more details.</td> </tr> </table>	Speaker Indicator	Indicates speaker being adjusted	Brightness UP Key	Press to increase brightness of the display and all visual indicators.	Brightness DOWN Key	Press to decrease brightness of the display and all visual indicators.	Home / TouchDisable Key	Long press disables touchscreen. The LED indicator (lock) is illuminated (red) while touch is disabled. Short press (re)enables touchscreen.	Status Indicators	Power, Disk Activity and Warning. See Figure B.3 for more details.
Speaker Indicator	Indicates speaker being adjusted										
Brightness UP Key	Press to increase brightness of the display and all visual indicators.										
Brightness DOWN Key	Press to decrease brightness of the display and all visual indicators.										
Home / TouchDisable Key	Long press disables touchscreen. The LED indicator (lock) is illuminated (red) while touch is disabled. Short press (re)enables touchscreen.										
Status Indicators	Power, Disk Activity and Warning. See Figure B.3 for more details.										
	<table border="1"> <tr> <td>Bar-Graph Display</td> <td> Green: loudspeakers volume level Red: VU-meter (actual signal level at the loudspeakers and the microphone) Orange: display brightness level </td> </tr> <tr> <td>PTT (Push To Talk) Key</td> <td> By default PTT, but can be set to PTM (Push To Mute) or any other key event. Blue backlight can be programmed to blink or turn ON/OFF upon press/release. </td> </tr> </table>	Bar-Graph Display	Green: loudspeakers volume level Red: VU-meter (actual signal level at the loudspeakers and the microphone) Orange: display brightness level	PTT (Push To Talk) Key	By default PTT, but can be set to PTM (Push To Mute) or any other key event. Blue backlight can be programmed to blink or turn ON/OFF upon press/release.						
Bar-Graph Display	Green: loudspeakers volume level Red: VU-meter (actual signal level at the loudspeakers and the microphone) Orange: display brightness level										
PTT (Push To Talk) Key	By default PTT, but can be set to PTM (Push To Mute) or any other key event. Blue backlight can be programmed to blink or turn ON/OFF upon press/release.										

Figure B.2 The Stripe (Keys & Indicators)





	Speakers	Blue	Indicates if volume setting is applied to left, right or both speakers
	Touchscreen	Red	Illuminated when touchscreen is disabled
	Power	Blue	Short blink: OFF (power saving mode) Long blink: SLEEP (standby) Continuous: ACTIVE (operating)
	Disk	Blue	Blinking indicates read/write activity of SSD
	Warning	Red	Illuminated when an error has been detected

Figure B.3 LED Indicators

B.2. Touchmonitor

The touchmonitor comprises a high-brightness, ultra-wide viewing angle TFT LCD and a touchscreen. The display is connected to the embedded computer via LVDS interface. The touchscreen is operated by the respective controller with USB interface to the embedded computer.

Brightness of the LCD and all visual indicators on the Stripe (Bar-Graph Display, LED Indicators and PTT Key backlight) is adjustable by Brightness UP and DOWN keys. Home/TouchDisable key can be used to temporarily disable touchscreen for cleaning purposes.

B.3. Embedded Computer

BeFREE 10 incorporates an industrial grade single-board computer, which operates the embedded touchmonitor and provides for an extensive connectivity to enable various external peripherals to be used along (see Chapter B.5 for more details). It is internally connected to the Tipro Controller (via USB and COM4) as well as with the Audio Section/Subsystem (via USB and Analogue Line-In/Line-Out signals).

The computer is based on Intel's integrated circuits, what enables a wide-range of operating systems to be applied. A solid state disk is used as a mass storage device. The heat generated by integrated circuits is transferred via a heat-pipe to an internal heat-sink, without a fan. As a result the BeFREE 10 is completely silent in operation, without moving parts.

B.4. Intercom (Audio Section)

The functional block diagram of the audio section is shown in Figure B.4 below. Left (Voice) and Right (Alert) Speaker are physically/electrically realized as two loudspeakers in parallel to double the output volume. The Central Speaker, along with associated hardware equalizer, emphasizes lower frequencies in order to improve naturalness and intelligibility of the reproduced speech.

Internal signal processing includes analogue-to-digital and digital-to-analogue conversion (block “USB AUDIO CODEC”), conditioning (amplification, attenuation, filtering ...), sensing and switching. The complete processing is programmable via ChangeMe software and can be dynamically modified during the operation in so-called On-Line operating mode (using HID API). USB and analogue signals can be mixed, resulting in up to four listening/output audio channels (2 x stereo signal) and two parallel recording/input channels (USB and analogue). The Echo-Cancellation circuitry is optional (see Chapter D.3 for more details).

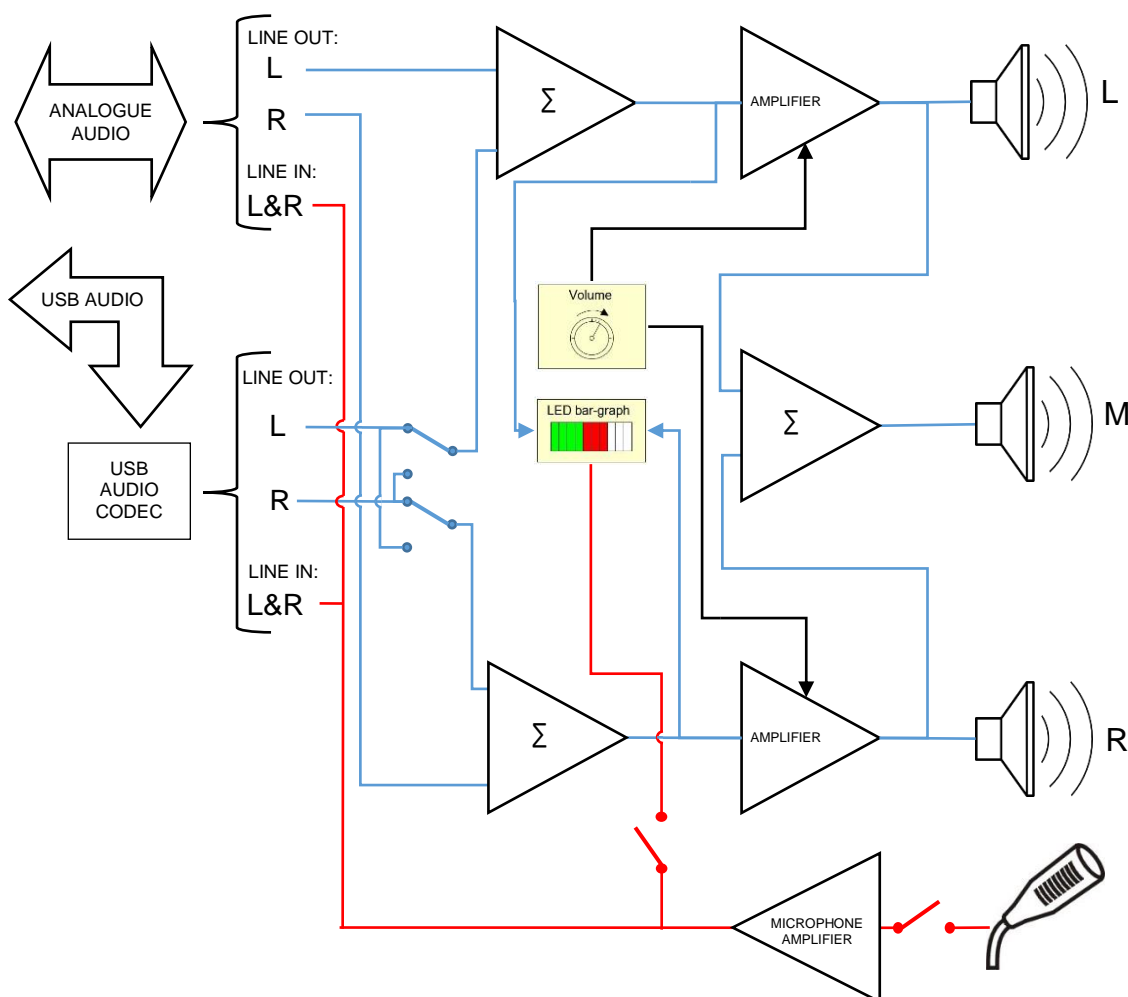

Figure B.4 Audio Section (Intercom)

B.4.1. Microphone Amplifier

This is a logarithmic audio amplifier with programmable gain, noise gating threshold and compression ratio. Noise gating feature enables ambient noise to be suppressed. All sounds below the threshold are removed inside the amplifier, so with higher threshold the microphone needs to be used closer to the mouth and speech needs to be louder to get through the amplifier. The compression feature enables compression of the output signal dynamics in order to minimize the difference between soft/low and loud speech. The amplifier is also capable of limiting extremely loud speech thus preventing distortion and popping. The overall gain can be even lower than one (i.e. attenuation) as well as equal to zero (i.e. totally muted input). Also the range of the goose-neck microphone can be adjusted.

A linear regime of the amplifier is a special option which might be activated in full-duplex operation where acoustic echo is to be cancelled using application software (rather than optionally integrated hardware echo-canceller – see Chapter D.3).

B.4.2. Hands-Free Amplifier

This is a linear audio power amplifier with programmable gain that drives the Voice (Left) Speaker. The gain of this amplifier (i.e. volume of the Voice Speaker) can be adjusted by the user in normal operation via the incremental encoder (i.e. endless digital potentiometer) at the rear right-hand side of the module. The selected level is immediately displayed at the bar-graph display in green colour (20 volume levels + mute). The amplifier can deliver up to 2 W (2 x 1 W) of electric power to the Voice Speaker.

B.4.3. Alarm/Alert Amplifier

This is a linear audio power amplifier with programmable gain that drives the Alert (Right) Speaker. The gain of this amplifier is normally equal to the gain of the Hands-Free amplifier, but it can also have a separate response characteristic to the position of the incremental encoder. This way, for instance, the Alert Speaker can be held at a constant volume level while increasing/decreasing volume level at the Voice Speaker. The amplifier is capable of delivering up to 2 W (2 x 1 W) of electric power to the Alert Speaker.

It is also possible to obtain completely independent volume adjustments of the Alert Speaker (see Chapter B.4.6).

B.4.4. Central Speaker Amplifier

This is a linear audio power amplifier with programmable gain and cut-off frequency, so it effectively acts as a programmable low-pass filter (which is a kind of an equalizer) capable to boost lower frequencies (typically below 300Hz) and improve naturalness of

the reproduced speech. It drives the Central Speaker by the “equalized” sum of signals to the Voice and to the Alert Speaker. The amplifier can deliver up to 3W of electric power to the Central Speaker.

B.4.5. Bar-Graph Display

It comprises 10 three-colour (red, green and orange) LEDs. By default it constantly operates as VU meter in red colour, showing actual level of the left output signal and the level of the microphone signal. Optionally, the microphone signal can be disconnected from the VU meter. It is also possible to add the right output signal, so the VU meter displays the sum of left and right outputs.

If a rotation of the incremental encoder has been detected it automatically displays the gain of the Hands-Free Amplifier in green colour.

If a press of brightness UP or DOWN key has been detected it automatically displays the current brightness setting of the LCD and all visual indicators in orange colour.

B.4.6. Incremental Encoder

This is an endless digital potentiometer used for immediate volume control of the Voice and Alert Speakers. It has 24 detents per revolution. Every single detent changes the volume for one step up or down, but only every second one is represented by one LED in the Bar-Graph display in green colour. The encoder incorporates a push-switch/ key which enables navigation through different bar-graph modes: Volume, Brightness and VU meter. In the Volume mode both Speaker Indicators on the Stripe are illuminated.

Optionally, the encoder enables independent volume control for each of the speakers. In this mode its internal push-switch is utilized to toggle the speaker to be adjusted. Currently adjustable speaker is indicated on the Stripe by the respective Speaker Indicator.

B.5. External Connectors

Numerous connections for external devices are available at the Connector Plate (see Figure B.5) from underneath the module. Most of them are standard interfaces (USB, LAN, COM, VGA ...) intended for users to apply freely.

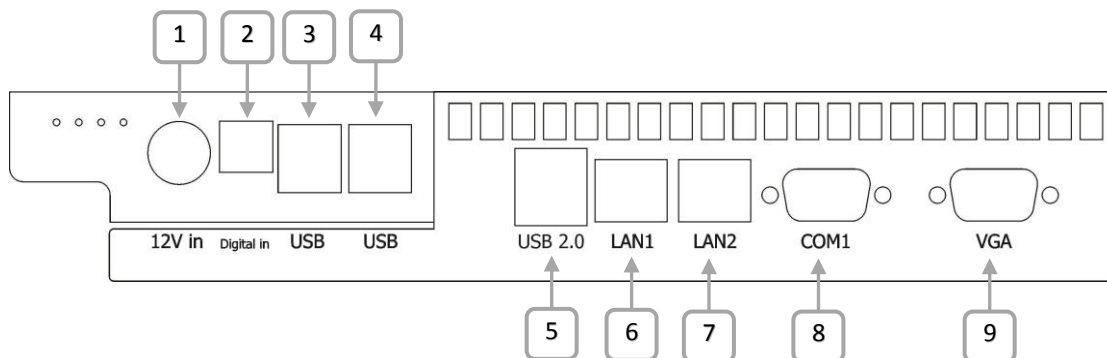

#	Designator	Type	Note
1	12V Input	Mini Power DIN	reserved
2	Digital Input	RJ 4P/4C socket	see Chapter B.5.1
3	Dual USB	2 × USB type – A	full-speed, 500 mA
4	Dual USB	2 × USB type – A	full-speed, 500 mA
5	Dual USB	2 × USB type – A	high-speed, 500 mA
6	LAN 1	RJ 8P/8C (RJ 45)	1 Gb Ethernet
7	LAN 2	RJ 8P/8C (RJ 45)	1 Gb Ethernet
8	COM 1	DSUB-9 male	RS232 serial port
9	VGA	DSUB-15 female	analogue RGB output

Figure B.5 Connector Plate

B.5.1. External Digital Inputs

Two inputs (refer to Figure B.6 for the connector and signal description) are provided for detection of external digital (ON/OFF) signals to be transformed into programmable key events, equivalent to, for instance, PushToTalk key on the Stripe. Typical device to be connected to is an external PushToTalk switch/pedal.

One of the inputs (A) is galvanically isolated (via opto-coupler) and is therefore intended for an external ground-referenced signal, such as a digital output of another

electronic device. The other input (B) is to be used for an external “floating” signal, such as contacts of a mechanical/magnetic key/switch (see Figure B.7).

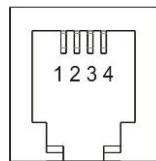

Pin #	Signal
1	A- (GND)
2	A+ (RxD)
3	B+ (TxD)
4	B- (GND)

Figure B.6 Digital Inputs Connector

Port	Internal circuitry	Suggested external circuitry
A		
B		

Figure B.7 Applying Digital Inputs

These inputs have an alternative function (direct access to the Tipro controller from an external computer via serial RS232 port, as per Figure B.6) which is intended for installation and maintenance purposes. More details can be found in the Chapter C.1 as well as in the Reference [10].

C. OPERATION

C.1. Configuring BeFREE 10

The BeFREE 10 is a rather complex device with a number of programmable settings/parameters provided for users to configure in accordance to the particular application. To enable that feature Tipro supplies the respective programming utility (**ChangeMe**) which operates only under Windows operating systems. It assists users to define own set of parameters, save them into a file (for possible replication in the future) and program into non-volatile memory of the Tipro controller for permanent storage.

It is also possible to dynamically modify certain settings (e.g. display brightness, LED indicators, touchscreen disable/enable for cleaning purposes ...) from the application software. For that purpose Tipro provides the respective Windows API (**HID API**) and the associated documentation.

BeFREE 10 can be programmed/configured externally, from another computer. That computer needs to operate under Windows with ChangeMe utility installed and have one serial COM port available. The BeFREE 10 may operate under any operating system or not have it installed at all. This feature is obviously useful in cases when the BeFREE 10 runs a non-Windows operating system, but it is also applicable in all Windows cases where ChangeMe utility is not installed (e.g. to prevent uncontrolled modifications of the settings). The cable required for programming can be ordered from Tipro (Ordering Code TM-CGR) or rather easily made. The Reference [10] describes the procedure in detail.

C.2. Applying BeFREE 10

The BeFREE 10 is typically used together with other **FREE** add-on modules, combined in various compositions/configurations. An example with Handset modules is shown in Figure C.1 below.



Figure C.1 Example BeFREE 10 Configuration

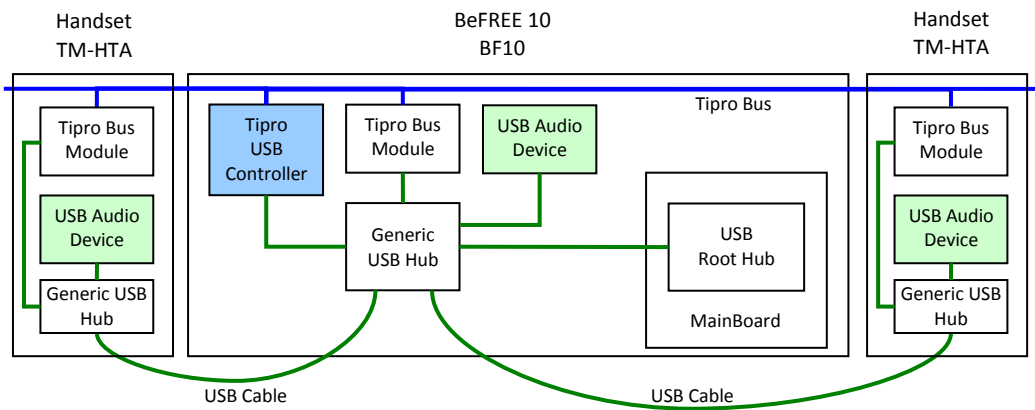

Figure C.2 Example BeFREE 10 Configuration – Schematic Representation

D. OPTIONS

D.1. Inclination Mechanism

BeFREE 10 can be fitted with an Inclination Mechanism (also referred to as Angle Adjustment Mechanism). Normally, the display surface of BeFREE 10 is inclined for 15° against the horizontal plane. The mechanism enables gradual adjustment of the angle from approximately 30° to 70° .



Figure D.1 BeFREE 10 with Inclination Mechanism (VESA 75)

D.2. HID Telephony Interface

Actual status (pressed/released) of the PTT key is normally reported as a programmable sequence of keystrokes generated by a standard USB keyboard, this way emulating a generic HID Keyboard Device. An example of the application can be found in the Reference [8] (“Hook and PTT in Software”).

Additionally or alternatively, the PTT status can be reported via HID Telephony Interface, which is an integral part of the BeFREE 10. See reference [9] (“HID Telephony Interface”) for more details.

D.3. Echo-Cancellation Circuitry

Acoustic echo is a physical phenomenon inherent to hands-free devices (such as Intercom) in full-duplex mode, so it needs to be suppressed and/or cancelled. This is normally implemented in the application software through the specific signal processing routines. Alternatively, it can be achieved in the hardware using a digital signal processor. Basic properties of the optional (see Chapter E.1 for details on the respective Ordering Code) Echo-Cancellation circuitry are listed below.

- ◆ **performance:** full-duplex
- ◆ **sampling rate:** 16 kHz
- ◆ **acoustic echo-cancellation:** ≥ 40 dB
- ◆ **latency:** ≤ 10 ms

Reference signal for the canceller is taken from the Voice Speaker. Optionally, the reference can be signal at the Alert Speaker as well as the sum of signals at both speakers.

D.4. Goose-Neck Microphone

By default, the goose-neck microphone is an integral part of the BeFREE 10, but it can be optionally omitted. See Chapter E.1 for details on the respective Ordering Code.

E. ORDERING CODES

E.1. BeFREE 10

1	2	3	4	5	6	7	8	9
BF	10	-	J D2	-	R U 0	-	C15C25	- xxx

1 – Module Type

BF – BeFREE (touchcomputer) module

2 – Model

10 : Integrated Intercom, 10.4” LCD

3 – Embedded Computer

J : Intel Celeron J1900 @ 2.0 GHz with 4 GB RAM

4 – Version & Connectivity

D2 : Fanless version with audio features (“Dispatcher”)

5 – Touchscreen Technology

R : ELO Resistive (zero-bezel)

6 – Integrated Audio Options

U : USB Speakerbox functionality

C : USB Speakerbox functionality with Echo-Cancellation Circuitry

V : USB Speakerbox functionality without goose-neck microphone

7 – Reserved

0 : none

8 – Housing Colour

C15C25 : black (C15) with black matte (C25) top part of the housing

This part of the code is not mandatory if the colour is C15C25, what is a default.

9 – Custom Version

Three-digit number reserved for product modifications. It is omitted in case of standard version.

Note 1:

BeFREE 10 requires 12V_{DC} power supply to operate (see Chapter A.2). The respective AC/DC adapter is included in the packaging, along with the EU power cord. For installations where AC/DC adapter needs to be placed further away (more than about 1m) from the BeFREE 10 Tipro offers the DC power extension cable (Ordering Code TM-CPH) which is 1.5 m long.

E.2. Inclination Mechanism

 1 2 3 4 5
TM - S U A - C15 - xxx

1 – Accessory Type

S – Mechanical Support mechanism (Inclination Mechanism)

2 – Mechanism Type

U : Universal

3 – Adapter Type

A : All BeFREES

4 – Colour

C15 : black

This part of the code is not mandatory if the colour is C15, what is a default.

5 – Custom Version

Three-digit number reserved for product customizations. It is omitted in case of standard version.

F. REFERENCES

1. “BeFREE 22” – Technical Overview
2. “BeFREE 20” – Technical Overview
3. “HANDSET” – Technical Overview
4. “SPEAKERBOX” – Technical Overview
5. “ChangeMe” – User’s Manual
6. “HID API” - Reference Manual
7. “Modularity Demystified” – “Dispatching Hints & Tips” White Paper – Issue No. 001
8. “Hook & PTT in Software” – “Dispatching Hints & Tips” White Paper – Issue No. 004
9. “HID Telephony Interface” – “Dispatching Hints & Tips” White Paper – Issue No. 005
10. “BeFREE 10/20/22 External Programming” – “Dispatching Hints & Tips” - Issue No. 006

G. NOTICES

G.1. Disclaimer

Information furnished by Tipro is believed to be accurate and reliable. However, Tipro makes no representations or warranties regarding the accuracy or completeness of the contents of this document and reserves the right to make changes to specifications and product descriptions at any time without notice.

G.2. Copyright Notice

© 2013-2019 Tipro. All rights reserved. Trademarks and registered trademarks are the property of their respective owners.